

17082

Lundy

GRPTW



Locally Owned & Operated
Since 1938



SWITCHES

FAN	ON-OFF	2001-0158
FLASHERS	ON-OFF	2001-0158
RED LIGHT		2001-0076
POWER	ON-OFF	2001-0158
STEERING	LEFT/RIGHT	2001-0120
LEVELING	UP/DOWN	2001-0120
PRIM POT.	SPEED	2001-0051
SEC. REV	REVERSING	2001-0900
LEFT PRIMARY	REVERSING	2001-0920
RT PRIMARY	REVERSING	2001-0920
2) STAKER	SPEED	2001-0112
SECONDARY	SPEED	2001-0112
PRIMARY	ON/OFF	2001-0158
CROSS	ON/OFF	2001-0158
COLLECTOR	UP/DOWN	2001-0120
BLADE	UP/DOWN	2001-0120
1- 2001-0069	SIGNAL STAT	2001-0120
1- 2001-0150	SIG. STAT BASE	CROSS STINGER
BUTTONS FOR HOLE BLANKS		2001-0431
1/2" HOLE		
CROSS STINGER	UP/DOWN	2001-0120

Distributors of Welding Gases, Supplies & Equipment

- | | | |
|----------------|-----------------------------|-----------------------------------|
| Gases | Welding Equipment | MRO Supply |
| • Industrial | • Welders & Plasma Cutters | • MRO Machinery |
| • Medical | • Cutting & Welding Torches | • Abrasives |
| • Specialty | • Fume Extraction | • Air Tools & Power Tools |
| • Bulk Systems | • Automation | • Hand Tools/ Safety / Janitorial |
| • Food Grade | • Consumables | • Paints & Lubricants |
| • Propane | • Accessories | • Clamping & Fixturing |

Don O'Brien

dobrien@puritygas.com
 p 989.775.0898
 c 989.621.2349
 f 989.779.1918
 2897 S. Isabella Road
 Mt. Pleasant, MI 48858
 www.puritygas.com

PREVIOUS
BUILD



POWER

ON/OFF



POWER ON

WHEN LIT



FLASHERS



FAN



LEVELING



STEERING



PRIMARY PUMP



ON WHEN LIT



SECONDARY

SPEED CONTROLLER



SHAKER



SECONDARY

CYLINDERS



COULTER



BLADE

REVERSING

07017

LUNDY

17082

6RPTW

PLUG #1

PIN

1	RED	2	COULTER MV5 VALVE
2	BLUE	3	LEVELING MV5 VALVE
3	ORANGE	4	SECONDARY RDRS112-30 ACTUATOR
4	YELLOW	5	FLASHERS
5	BROWN	6	SECONDARY REVERSING VALVE
6	RED	7	COULTER MV5 VALVE
7	BLUE	8	LEVELING MV5 VALVE
8	ORANGE	9	SECONDARY RDRS112-30 ACTUATOR
9	BLUE	13	LEFT SHAKER RDRS112-30 ACTUATOR
10	ORANGE	14	LEFT PRIMARY REVERSING - FORWARD
11	BLACK	17	STEERING MV5 VALVE
12	RED	18	BLADE MV5 VALVE
13	ORANGE	19	LEFT PRIMARY REVERSING - REVERSE
14	BROWN	21	CROSS CONVEYOR SWITCH TO SV3-16 SOLENOID
15	BLACK	22	STEERING MV5 VALVE
16	RED	23	BLADE MV5 VALVE
17	BLUE	24	LEFT SHAKER RDRS112-30 ACTUATOR
18	WHITE	28	CROSS CONVEYOR MV5 VALVE
19	BLUE	29	CROSS CONVEYOR MV5 VALVE
20	ORANGE	30	RIGHT PRIMARY REVERSING - FORWARD
21	GREEN	31	RIGHT PRIMARY REVERSING - REVERSE
22	RED	32	RIGHT SHAKER RDRS112-30 ACTUATOR
23	YELLOW	33	RIGHT SHAKER RDRS112-30 ACTUATOR
24			
25			
26			
27			
28			
29	BELDEN	8762	CLEAR TO PIN "C" COIL #2 - GREEN FROM KAR-TECH CONTROLLER
30	BELDEN	8762	BLACK TO PIN "D" COIL #2 TO PANEL GROUND
31			
32			
33			
34			
35			
36			
37			

3 - PIN PLUG

PIN #	1	RED	+ 12VDC POWER SUPPLY	8 AWG
	2	BLACK	- GROUND	8 AWG
	3			
PIN #	1	RED	+ 12VDC POWER TO COOLER FANS	10 AWG
	2	BLACK	- PANEL GROUND TO FRAME GROUND	10 AWG
	3			

LABELS
LUNDY #17082

Green Background
White Lettering

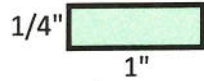

- 1- Cooler Fan
- 1- Flashers
- 1- Power On
- 1- When Lit
- 1- Power
- 1- On/Off
- 1- Steering
- 1- Leveling
- 1- Speed
- 2- Secondary
- 1- Left
- 1- Right
- 1- Shaker
- 1- Primary
- 1- Cross
- 1- Coulter
- 1- Blade

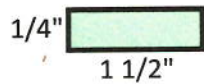

- 1- On When Lit

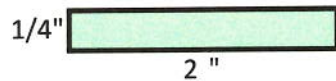

- 1- Primary Pump
- 1- Primary
- 1- Speed Controls
- 1- Cylinders

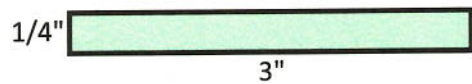

- 1- Reversing

AFE New Equipment Chain Verification Sheet

Chain For HJV / Lundy #17082 6RPTW

AFE Part #	Description	Brand	Location
2003-00531	1/2x33-1/2x50mm 2x60 1STPL-2DNPL HT 109+	Broekema	Primary (6)
2003-00368	7/16x68-1/2x50mm 3x60 STSRT 68+	Noffsinger	Secondary (Short)
2003-00369	7/16x68-1/2x50mm 3x60 STSRT 74+	Noffsinger	Secondary (Middle)
2003-00370	7/16x68-1/2x50mm 3x60 STSRT 78+	Noffsinger	Secondary (Long)
2003-00205	5/8x68x150mm 2x60 STSRT 47LPR	Broekema	Deviner (3)
2003-00550	7/16x40x45mm 2x60 STSRT 372+	Broekema	Rear Cross

REVISED 2017-01-24 per Lundy/HJV signed copy. See file.

Dealer Rep _____ Date _____

Customer _____ Date _____

PULL TYPE WINDPOWER

12-13-16
 *17082
 LUNDA
 6RPTW

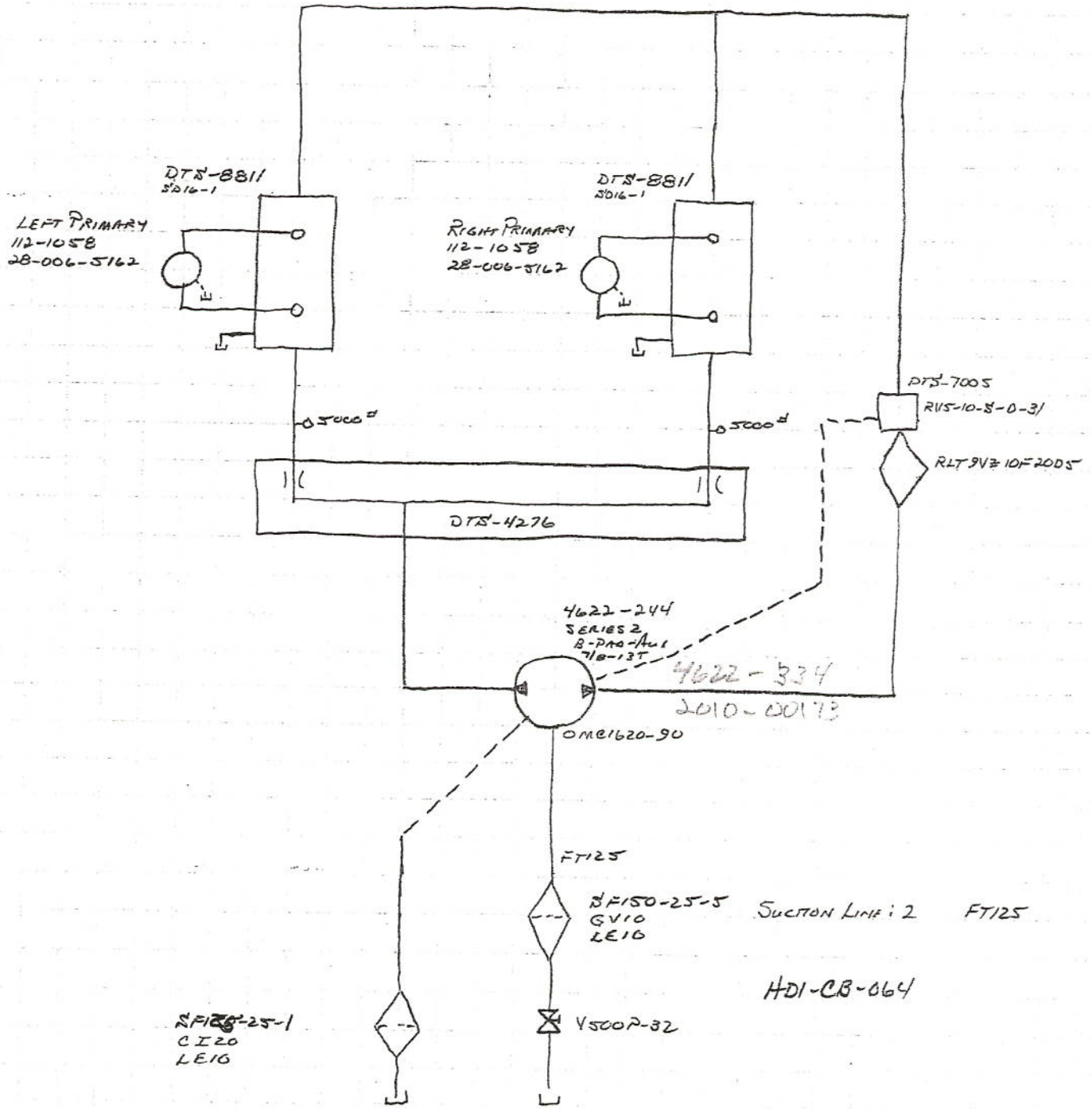

PULL TYPE WINDROWER

#17082

LUNOY
6 RAT W

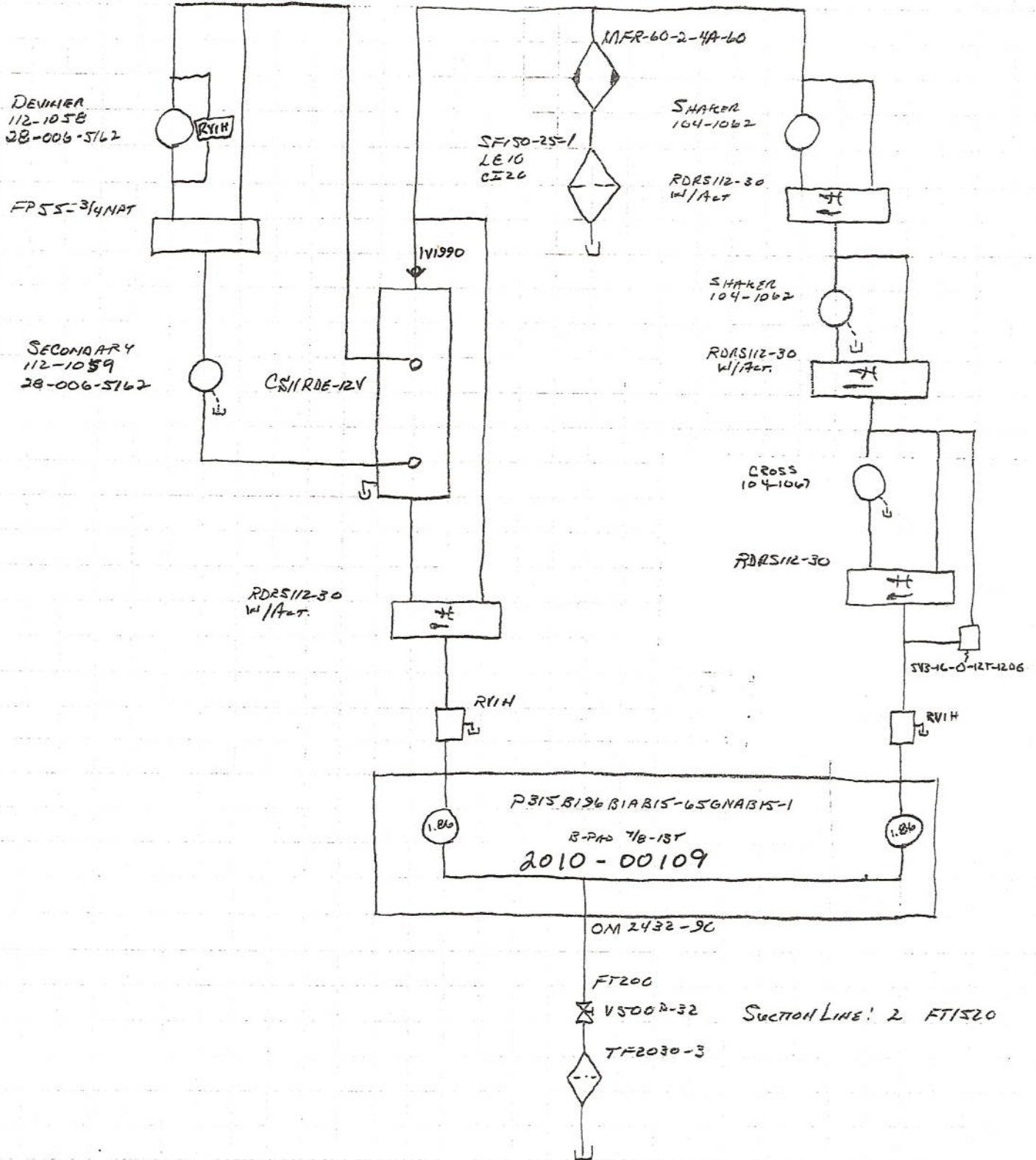

2170B2
LUNAY
WRPTW

Pneumatic Hydraulic

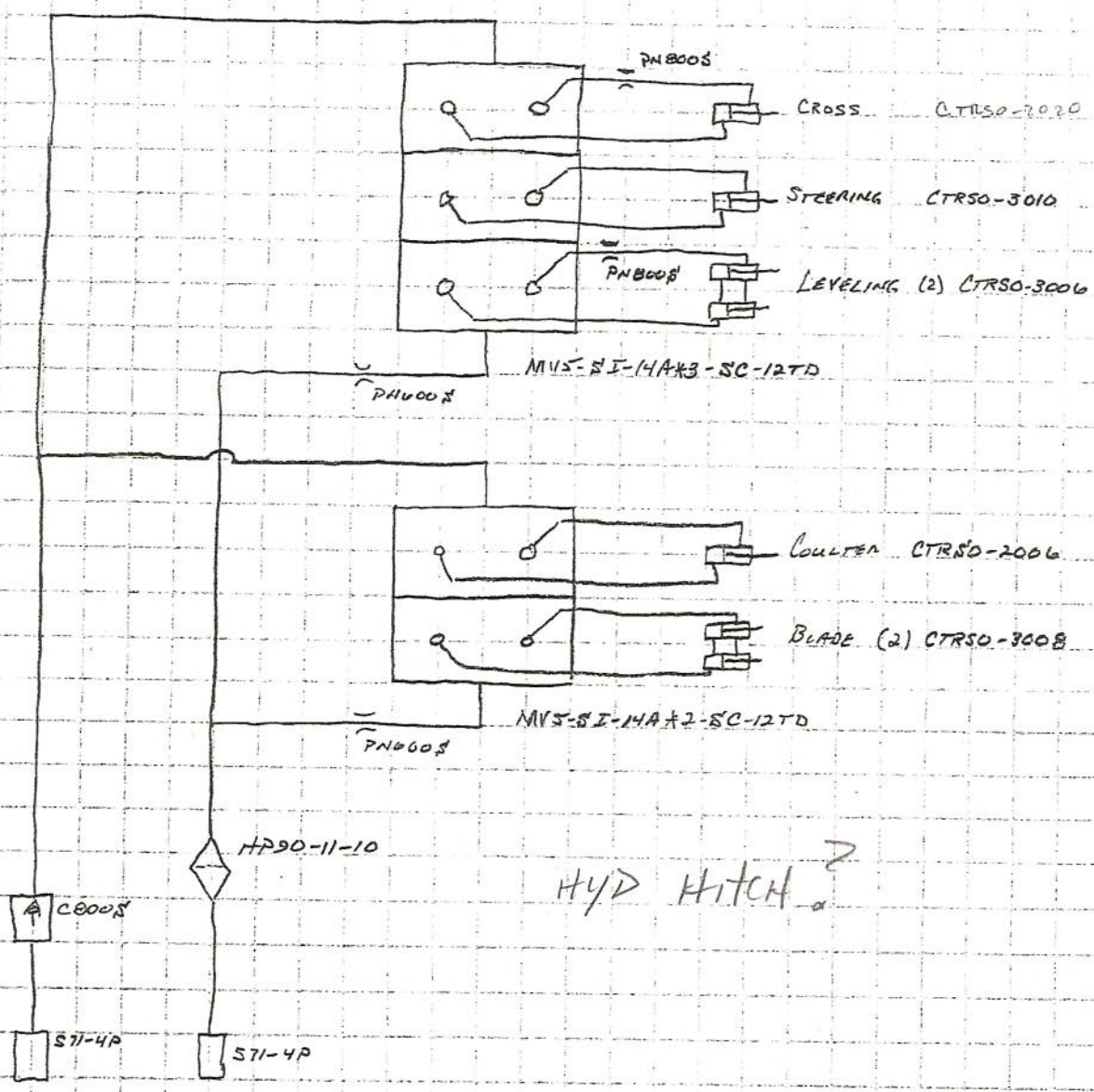

HYD HITCH ?

HYDRAULICS FINISH MATERIALS LIST

BEGINNING DATE
END DATE

PROJECT NO. *Lundy other Finish*

QTY	PART NUMBER	DESCRIPTION
15	2035-01001	3 1/2" KRYPTANE w/5" FLANGE Rubber
6	2035-01000	3 1/2" KRYPTANE Rubber roller w.o/Flange
20	2035-01008	3 1/2" steel w.o/FLANGE
42	2035-01009	3 1/2" steel w/FLANGE
12	2035-01010	3 1/2" Rubber w.o/FLANGE
2	2035-01011	3 1/2" Rubber w/FLANGE
1	2035-01030	3 1/2" steel w/8" FLANGE
52	2035-00027	4" KRYPTANE (SUPERIOR STYLE) CARRY BACK
20	2035-00028	5" KRYPTANE (SUPERIOR STYLE) CARRY BACK
24	2035-05004	4" steel. Vibrator Roller no stand off
12	2035-H50M14R1E4A	Primary Sprockets
9	2035-H50M17R1E4A	Secondary Sprockets
2	2035-H45M10R1B5X	CROSS sprockets
2	DSR 2460	Coultor blades
2	31011-007	Coultor Hub protectors
1	2002-17	Serial Number plate
1	140-15548	P.T.O Shaft
2	800-5500	u-joint
1	101-5520	Yoke
1	101-5521	Yoke
1qt	1540	ENGINE oil Schaffers
4qt	80w-90	GEAR Lube
1	2002-01	Slow moving sign
1	2002-15	Rotating DRIVE LINE
1	2002-08	High Press. Fluid
4	2002-10	Rotating PARTS HAZARD
2	2002-16	DANGLY moving PART
6	2002-07	MOVING PARTS HAZARD
6	2002-04	SMALL Lenco DECALS
1	2002-05	LARGE Lenco DECAL

Parts List

Lundy 6 Row Windrower 17082 2017

Qty	Part #	Description
6	013-40012	34 1/2" HD Digger Blade Bracket W/Stone Gard
2	013-30136	3/4"x12" Deep, Full Width Digger Blade 104 1/4"
6	013-30025	14" Wide 12" Deep Center Point
2	2027-00008	881 Hub Kits
2	2027-01008	881 Spindle Kits
2	2018-26-25-881-2	Rims
2	2018-28L-26TT	Tractor Tread Tires
3	2015-014	LE-10 Filters
1	2015-003	HP26-10 Filter
1	2015-010	9VZ10 Filter
6	2035-H1506-LE	150mm Bolt On Deviner Sprockets
2	2035-H45M10RE4X	45mm 10TH Reverse Wrap Drive Sprockets
12	2035-H50M14R1E4X	50mm 14TH 1/2" Rod 2" Bore No Pegs
9	2035-H50M12RE4X	50mm 12TH 7/16" Rod 2" Bore No Pegs
1	2023-0179	Windrower Gearbox HD1-CB-064
1	2010-00173	4622-334 Primary Pump
1	2010-00109	Secondary/Cross Tandem P315196
2	2011-00017	Primary Hyd. Motor
1	2011-00018	Secondary Hyd. Motor 112-10
1	2011-00011	Cross Conv. Hyd. Motor 104-1067
1	2011-00007	Shaker Motor 104-1062